



UPS Megaline

EN

ENGLISH

3



Index

1	Introduction	4
1.1	Important information	4
2	Funzionamento	5
2.1	Operating principle	5
2.2	Mains operation	6
2.3	Battery operation	6
2.4	By-pass operation	6
2.5	Information provided by the display	6
2.6	Visual and acoustic warning signals	7
3	Installation	8
3.1	Prior to installation	8
3.2	Where to install your UPS	8
3.3	Front panel	9
3.4	Installation procedure for a single cabinet UPS	9
3.5	Presetting for the expansion of autonomy	11
3.6	Installation procedure for a double cabinet UPS	12
3.7	Guide to using the diagnostics software	14
3.8	Operating procedures	14
4	Customising the UPS operating mode	15
4.1	The functions of the buttons	15
4.2	The "Service Mode" function	15
4.3	Accessing menus	15
4.4	UPS status	16
4.5	UPS configuration	18
4.6	Events	22
4.7	Programming	23
4.8	Tools	24
5	Specifications	24
5.1	Construction specifications	24
5.2	Environmental specifications	25
5.3	Electrical input specifications	25
5.4	Output waveform	26
5.5	Electrical output specifications when running on mains power	26
5.6	Electrical output specifications when running on battery power	27
5.7	Battery operation	28
5.8	By-pass specifications	29
5.9	Reference standards	29
6	Troubleshooting	30

1. Introduction

Thank you for choosing to purchase a LEGRAND® product. Our company's main objective is to supply innovative products that are the outcome of our ongoing research and application of cutting-edge technology.

Our products are covered by several international patents, emblematic of LEGRAND®'s quest for exclusivity and ongoing improvement.

LEGRAND® uninterruptible power supplies are designed to protect electronic equipment from problems that may be encountered with your mains electricity supply, such as power cuts, surges and interference.

In particular, the product you have purchased is enhanced with our exclusive "State of Charge Algorithm" which makes it possible for your UPS to achieve the best possible performance in terms of autonomy.

Our products comply with international standards: an additional guarantee of the quality of our products.

We recommend you read this manual carefully and keep it for future reference.

1.1 Important information

- Do not connect loads in excess of the limit stipulated on the product's label and in the relative documents provided.
- Do not dismantle the UPS. Only authorised technical personnel are allowed access to the internal parts of the UPS.
- Never disconnect the UPS from the mains power supply when it is running: this would cut off the earth protection of both the UPS and of the loads connected to it.
- Do not insert screwdrivers or other items inside the ventilation holes or into the fan.
- The UPS must be installed according to the instructions in this manual and in compliance with the set limits.
- Take care that no liquids come into contact with your UPS.
- This product should only be employed for the designated uses described in this manual.
- The manufacturer is not liable for any damage or injury caused by failure to comply with the instructions in this manual.

All the information contained in this manual is provided as a guide and is subject to change without notice for product upgrading.

2. Operation

Block diagram

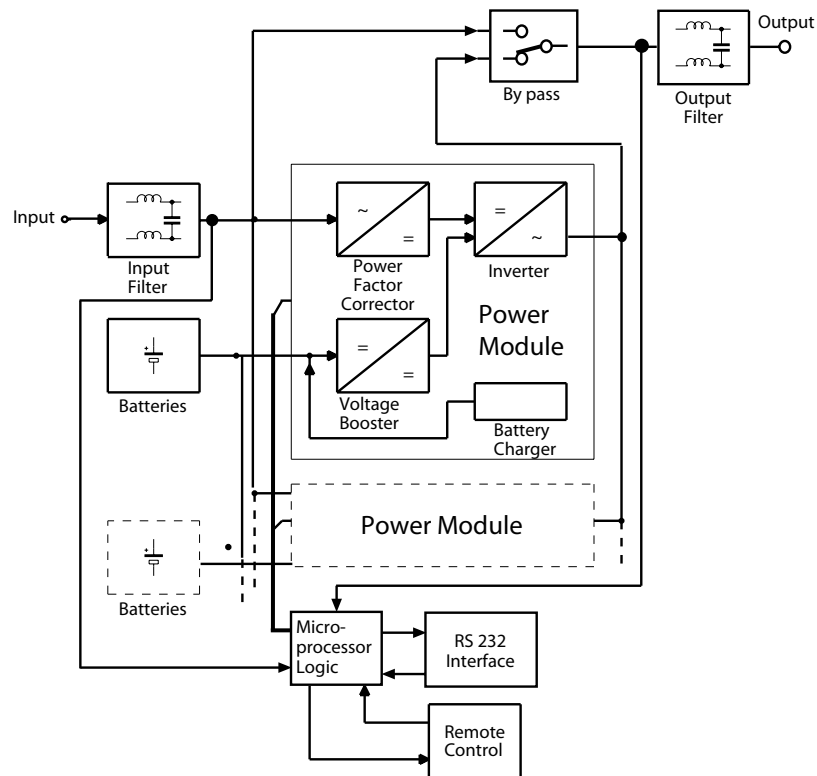

2.1 Operating principle

When the mains supply is present, the input voltage is filtered and rectified by a special input stage (power factor corrector) which is able to optimise the absorption of current from the mains, so that the power factor becomes practically unitary, and to compensate for any shifts in voltage. This stage is able to supply the output inverter even in conditions of very low mains voltage.

This feature becomes very striking with very low loads: with a load of around 50% nominal load, mains operation is possible as low as about 100 V without any exploitation of battery power. This enables more "intelligent" management of the switchover to battery power, minimising use of the batteries. The voltage is rectified at the first stage and then taken up by a high frequency inverter to produce the 'clean' sinusoidal output voltage, offering very low distortion rates.

A rapid, synchronised by-pass circuit intervenes during peaks of absorption above the inverter's capacity, for example when certain peripherals are switched on, demagnetisation of large colour monitors, etc.

Should the mains voltage fail or be subject to excessive sag, a booster stage is automatically activated.

This employs the batteries and safeguards the supply of power to the output inverter, and thus to the load, without any break. The circuitry is a passing neutral type, i.e. with no alteration of the neutral system of the appliances connected to it. During normal operation, a sensor verifies the difference in potential between the neutral wire and the earth wire: should this be excessive, it will activate the input protection and switch the UPS over to battery mode, signalling the anomaly.

It is, however, possible to modify the parameters of the software so that only signalling is provided, if preferred.

All the UPS functions are supervised by a microprocessor that is also able to control and memorise certain operating conditions, in addition to managing the UPS interface with a computer by means of a RS 232 serial line.

This makes it possible to control the operating functions and any anomalies in real time.

The UPS keeps the operator informed regarding its operating status using visual and acoustic signals:

- alphanumeric display **1** on page 9
- status indicator **7** on page 9
- acoustic signal (located inside the UPS)

2. Operation

The combination of these signals enables rapid and intuitive understanding of its operating status and recognition of any problems in the power supply.

There are three main operating modes

- Mains operation
- Battery operation
- By-pass operation

2.2 Mains operation

This is considered the normal operating condition:

- mains voltage is converted by the power factor corrector (PFC) into continuous current
- the inverter reconstructs the sinusoidal voltage from the continuous current
- the output filter provides extra "cleaning" of the output voltage
- the batteries are recharged

2.3 Battery operation

When there is a mains power failure, the UPS automatically switches over to battery mode.

- the voltage of the batteries is increased by the "booster" circuit
- the inverter reconstructs the sinusoidal voltage from the continuous current
- the output filter ensures the voltage supplied to the load is clean

2.4 By-pass operation

The by-pass circuit excludes the UPS and connects the output directly to the input. The switchover takes place in a synchronised manner in order to ensure the correct output voltage is always guaranteed, preventing the risk of a break in power or excess voltage.

The intervention of the by-pass circuit can be customised by means of a dedicated menu (Config. UPS, By-pass) which provides many options (automatic, disabled, by-pass in load waiting mode, etc.) in order to meet the specific demands of the application.

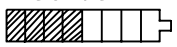

2.5 Information provided by the display

The main messages provided by the alphanumeric display in the three different operating modes are illustrated below.

UPS on mains	
IN	212V
OUT	230V/812W (31%)
Batt	 32,2'

UPS	On Mains	Indicates normal operating status, when mains voltage is present.
	On Battery	Indicates that there is no mains power and the UPS is using its batteries to supply power.
	On By-pass	Indicates that by-pass operation has been turned on: the output of the UPS is connected directly to the mains.
IN	xxxV	Indicates the UPS input voltage and the RMS power absorbed by the mains. This message is not displayed during battery operation.
OUT	xxxV/x,xKW (xx%)	The current power is also given as the percentage of the total power that the UPS is able to supply.
Batt.	xx,x?	Indicates the state of charge of the batteries in a chart format and the autonomy available in a numeric format.

2.6 Visual and acoustic warning signals

Status indicator	Acoustic signal	Messages displayed	Description
Green	-	UPS on Mains IN xxxV	Normal operation with mains present and loads within the set limits
Green Fast flashing	-	UPS on Mains No sync mains xx.xHz	The UPS is indicating that the frequency of the output voltage is not synchronised with the input voltage. The cause of this may be: - PLL disabled - Frequency of the input voltage is outside the set limits for the UPS
Yellow	Short intermittent sound (every 20sec)	UPS on Batteries MAINS ABSENT	Battery operation
Yellow Fast flashing	-	UPS on Bypass	By-pass operation
Red Fast flashing	Short and fast intermittent sound	-	Module failure  ATTENTION! We recommend you switch off the ups and contact your service centre Overload  ATTENTION! We recommend removing some of the appliances connected to the ups so that consumption by the load returns below set limits
Red	Continuous sound	-	UPS error or failure  ATTENTION! We recommend you switch off the UPS and contact your service centre
Red 1 flash every 10 secs.	-	-	Above 90% of MAX load
Red Alternating short long flashing	Alternating short, long intermittent sound	RESERVE AUTONOMY!	Autonomy reserve. During battery operation Incorrect battery connection Incorrect Neutral
Red Short flashing with pause	-	OUT OF REDUNDANCY!	Consumption by the load is above the redundancy that has been set. Power board redundancy is not guaranteed in case of failure

NB: press  to silence the acoustic signal. The signal will be silenced or enabled each time this button is pressed.

3. Installation

3.1 Prior to installation

Check the packaging has not been opened or damaged and that the product has not been damaged during transport. Please contact your shipping agent in case of doubt.

Check the contents of the box:

- Nr.1 UPS
- Nr.1 connector for the input/output cable (single cabinet version includes multiple output socket and input cable)
- Instructions manual

We recommend you keep the equipment's packaging materials as they can be useful should the need arise to send the product back for repairs.

3.2 Where to install your UPS

Make sure the place where you intend installing your UPS is level and sturdy.

Please comply with the following requisites for installation (Fig. 1):

- The UPS must be located in an enclosed environment: it was not designed to operate out of doors.
- It is essential that you comply with the environmental conditions illustrated in this manual.
- Avoid placing it in very dusty or damp areas or in direct sunlight.
- Avoid places where there are inflammable liquids and/or corrosive substances.

- Ventilation must be guaranteed by placing the UPS at least 20 cm away from any walls
- Do not cover the ventilation outlets on the front, rear or sides of the UPS

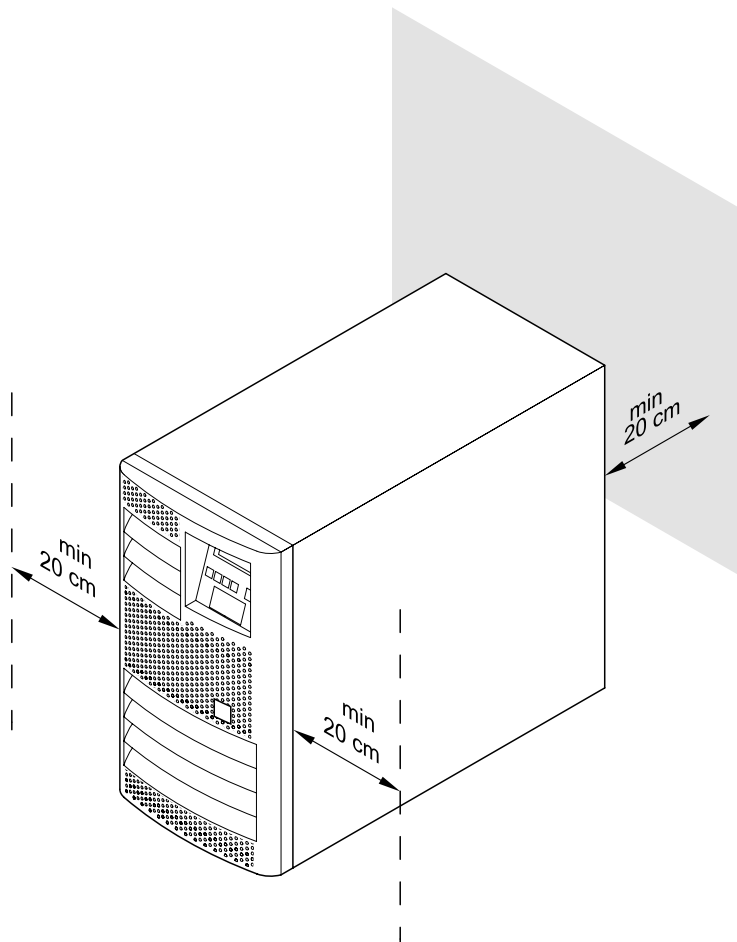
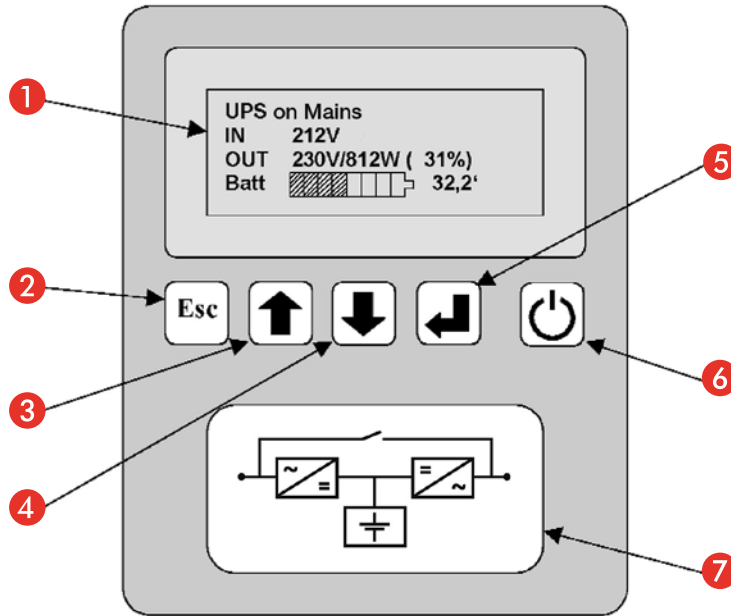

Fig.1
Where to install
the UPS.

3.3 Front panel



- 1 Alphanumeric Display
- 2 ESC button / exit function / silence acoustic signal
- 3 Button to scroll backwards / increase value
- 4 Button to scroll forwards / decrease value
- 5 Enter button / confirm function / access menu
- 6 Button to switch on / switch off
- 7 Multicolour operating status indicator light (green / yellow / red)

3.4 Installation procedure for a single cabinet UPS

3.4.1 Electrical connections

Single Cabinet (fig. 2):

- 8 Input/Output connector
- 9 Input/Output plug
- 10 Input fuse
- 11 RS232 serial interface outlet (9-pin female)
- 12 Logic signals outlet (9-pin male)
- 13 Presetting for expansion of autonomy

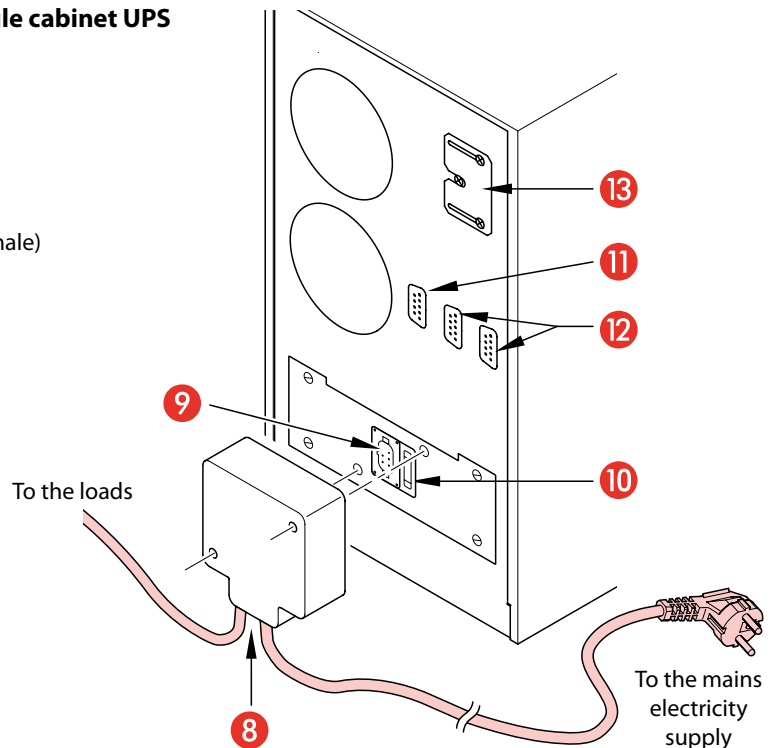

Fig.2
Electrical
Connections.

3. Installation

3.4.2 Single cabinet

1. Wire up the Input-Output connector supplied as shown in figure 3, using insulated cable with wires whose section is at least **2.5 mm²**.
2. Insert the connector into the plastic housing and secure it using the screws supplied. Secure the wires to the housing using the cable grip (see fig. 3).
3. Take the cover off the plug [9] by removing its screws.
4. Put the Input-Output connector into the plug [9] located on the rear of the UPS, and secure to its case using the screws supplied (see fig. 2).
5. Check that the on/off switches of all the appliances to be connected to the UPS are OFF and connect them to the output socket.
6. Insert the power supply plug into a power outlet that is adequate for the voltage and current required.

Input-output connector - Assembly

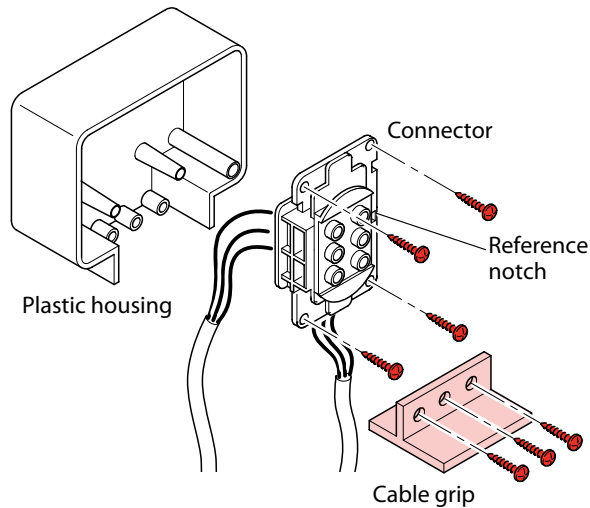

Fig. 3
Connection
terminals housing.

WARNING
Your UPS is fitted with a circuit to protect it against the risk of incorrect connections. This eventuality will be indicated by means of its red warning light, lit without flashing, and the continuous sounding of its internal buzzer. Should you note this signal immediately after switching the UPS on, switch it off and remove the power supply plug immediately.

3.4.3 Precautions for installation

- Electrical connections should only be done by trained personnel
- Do not modify the electric cables supplied
- Make sure that the mains outlet is connected securely to an earth circuit
- The mains outlet, or the circuit breaker, must be installed near the appliance and must be easily accessible

ATTENTION
(for versions 3 103 46/3 103 47/3 103 48/3 103 49)
The cables supplied are fitted with an input plug and outlet sockets whose maximum capacity is 16A. Therefore, we recommend use of direct cabling from the control panel to the connector supplied (follow instructions for connections shown in Figs. 3 and 4 on Page 11) for applications where the anticipated UPS input current will be in excess of 13A (e.g. 5000 VA with $V_{in}=184V$)

ATTENTION
(for versions 3 103 46/3 103 47/3 103 48/3 103 49)
Since current dispersion towards earth of all the loads merges in the UPS protection wire (earth wire), it is essential to check that the sum of these currents does not exceed 2.7 mA, according to standard EN 62040-1, for safety reasons.

Input-output connector - Side with insertion of wires

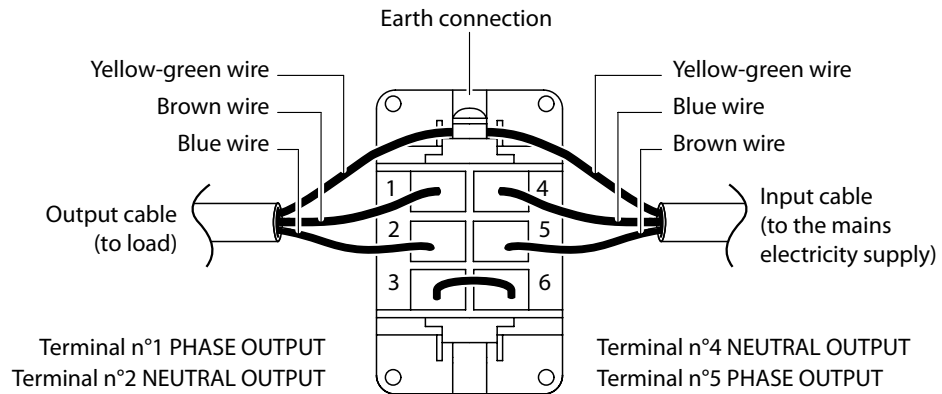

Fig. 4
Terminals.

3.5 Presetting for the expansion of autonomy

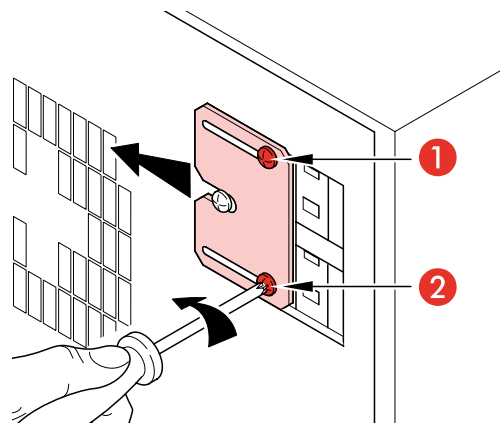

Fig. 5.

Your UPS is complete with presetting for the connection of additional battery cabinets. One or more extra battery cabinets can be fitted to a single cabinet UPS as follows:

1. Loosen screws **1** and **2** shown in figure 5, but do not unscrew them completely.
2. Slide the protective casing to the left so that the connectors located inside the box are completely accessible.
3. Tighten the screws to secure the metal protection.
4. Connect the battery cabinet to the UPS using the dedicated cables.
5. Use the plaited conductor supplied to safeguard a good contact with earth.

! ATTENTION Make sure the UPS has been switched off and disconnected from the mains supply before proceeding with connections.

! ATTENTION The cables supplied with the battery cabinet were designed for connection to the UPS cabinet of double cabinet UPS versions (3 103 60, 3 103 63, 3 103 66, 3 103 69, 3 103 72): in this case, all three cables supplied must be connected. For single cabinet versions (3 103 46, 3 103 47, 3 103 48, 3 103 49) use only 2 of the 3 cables supplied.

3. Installation

3.6 Installation procedure for a double cabinet UPS

Double Cabinet (fig. 6):

- 8 Battery connections
- 9 Input/Output plug
- 10 Mains fuses
- 11 RS232 serial interface outlet (9-pin female)
- 12 Logic signals outlet (9-pin male)
- 13 Copper plaited conductor

3.6.1 Double Cabinet.

The following connections are located on the rear of the UPS:

Inverter Cabinet

- Input-Output Plug [9]: connect the previously wired connector supplied in the bag of accessories to this plug.
- Outlet for connection of RS232 type computer serial interface (9-pin female) [11]: this is used if you want to use the diagnostics or shutdown software.
- Two sockets for connection of a remote control and logic signals computer interface (9-pin male) [12]: for use with the relative devices (optional).
- Output for Battery Cabinet connection cables [8].
- Screw for earth connection of battery cabinet [14].

Battery Cabinet

- Connector for connection to the Inverter Cabinet using the cables supplied [8].
- Screw for earth connection of case [14].

Follow the steps below for installation:

1. Looking at the UPS from the front, put the Battery Cabinet to the left of the Inverter Cabinet; also check that the ventilation holes are not blocked.
2. Connect the earth between the two cabinets using the copper plaited conductor supplied, as shown in fig.6.
3. Connect the Battery Cabinet using the cables supplied (there should be no remaining free connectors: use all the cables supplied).
4. Wire up the Input-Output connector supplied as shown in figure 8, using insulated cable with wires whose section is at least 4 mm².
5. Insert the connector into the plastic housing and secure using the screws supplied. Insert the wires into the appropriate holes and secure them using the two cable grips (see fig. 7).
6. Take the cover off the plug [9] by removing its screws.
7. Put the Input-Output connector into the plug [9] located on the rear of the UPS, and secure to its case using the screws supplied (see fig. 6).
8. Check that the on/off switches of all the appliances to be connected to the UPS are OFF and connect them to the output socket.
9. Insert the power supply plug into a power outlet that is adequate for the voltage and current required.



WARNING

Never remove the 230 V power plug whilst the UPS is in operation: this would disconnect the earth protection of both the UPS and of the connected loads.



ATTENTION

(for versions 3 103 60; 3 103 63; 3 103 66; 3 103 69; 3 103 72)

Since current dispersion of all the loads towards earth merge in the UPS protection wire (earth wire), it is essential to check that the sum of these currents does not exceed 2.7 mA, according to standard EN 62040-1, for safety reasons.



WARNING

Your UPS is fitted with a circuit to protect it against the risk of incorrect connections. This eventuality will be indicated by means of its red warning light, lit without flashing, and the continuous sounding of its internal buzzer. Should you note this signal immediately after switching the UPS on, switch it off and remove the power supply plug immediately.

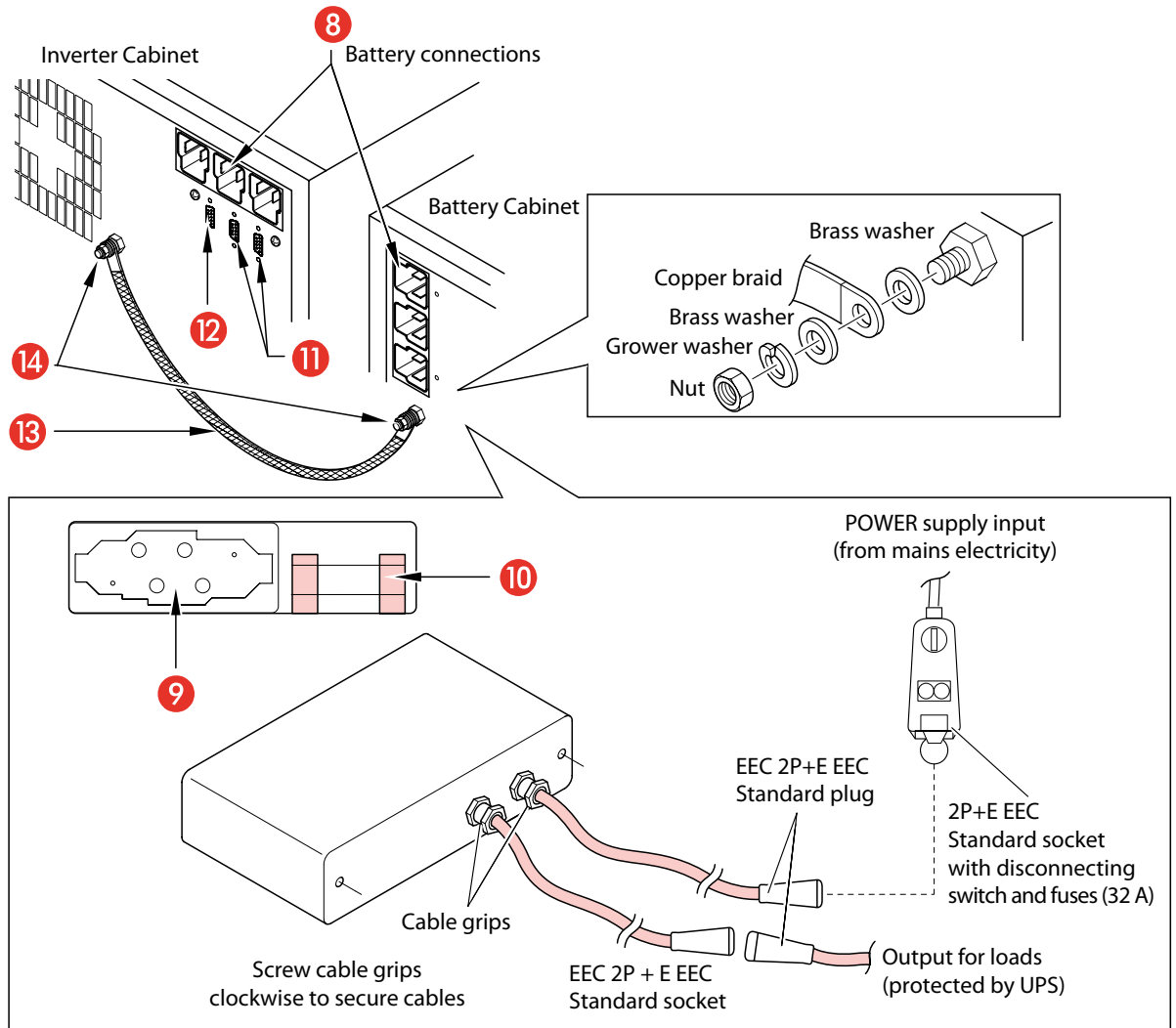

Fig. 6.

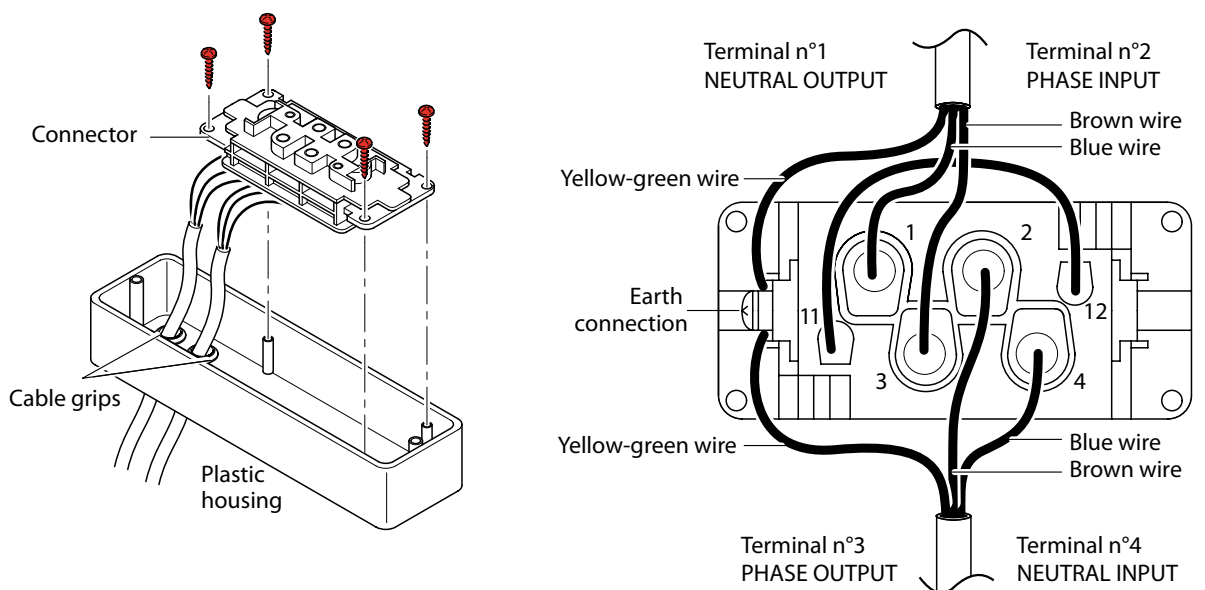

Fig. 7.
Housing of
double cabinet
connection
terminals.

Fig. 8.
Double cabinet
connection
terminals.





3. Installation

3.7 Guide to using the diagnostics software

3.7.1 Connection

Your UPS is fitted with a standard RS232 interface, which can be used in conjunction with a computer in order to access data relating to the operation of the UPS and its log. This function must be used together with the interface programme for WINDOWS environments available from our website www.ups.legrand.com without charge. A RS232 cable is required to connect a serial port on your PC to the interface outlet [11] located on the rear of the UPS.





3.8 Operating Procedures



Switch on	Switch off
<p>Press button</p>  <p>The display reads</p> <div style="border: 1px solid black; padding: 5px; width: fit-content; margin: 10px auto;"> <p>UPS switching on....</p> </div> <p>The status indicator shows the sequence during switch on (red, yellow, green). The display shows the operating status (example).</p> <div style="border: 1px solid black; padding: 5px; width: fit-content; margin: 10px auto;"> <p>UPS on mains IN 212V OUT 230V/812W (31%) Batt  32,2'</p> </div>	<p>During operation (example)</p> <div style="border: 1px solid black; padding: 5px; width: fit-content; margin: 10px auto;"> <p>UPS on mains IN 212V OUT 230V/812W (31%) Batt  32,2'</p> </div> <p>Press button for a few seconds</p>  <p>The acoustic warning signal sounds repeatedly then the UPS switches off (5 seconds).</p>

4. Customising the UPS operating mode

4.1 The functions of the buttons



The buttons on the front panel of the UPS are used to access its various menus.

Button	Description
	<ul style="list-style-type: none"> - Exit a function without modifying it - Go up a level to an upper level menu - Exit the main menu and return to status display - Silence the buzzer
	<ul style="list-style-type: none"> - Select previous function - Increase a value within the function - Select a new item within the function (e.g. go from DISABLED to ENABLED)
	<ul style="list-style-type: none"> - Select next function - Reduce a value within the function - Select a new item within the function (e.g. go from ENABLED to DISABLED)
	<ul style="list-style-type: none"> - Confirm a value - Access an item in the menu - Go down a level to a lower level menu

⚠ ATTENTION: Some menus contain more than four lines: use the   buttons to scroll through items in the menu that are not displayed.

4.2 The “Service Mode” Function

All the settings and programming described below can be done even when the UPS is switched off.

Press the  button to enter UPS “SERVICE” mode in order to access the Display menu. Press the  button to exit this mode. Alternatively, the UPS will automatically exit the function and switch off if it does not receive manual or serial commands within 1 min.

4.3 Accessing menus

When the UPS switch on procedure has been completed, the display will read (example).

UPS on mains	
IN	212V
OUT	230V/812W (31%)
Batt	 32,2'

Press the  button to access the main menu.

4. Customising the UPS operating mode

Main menu

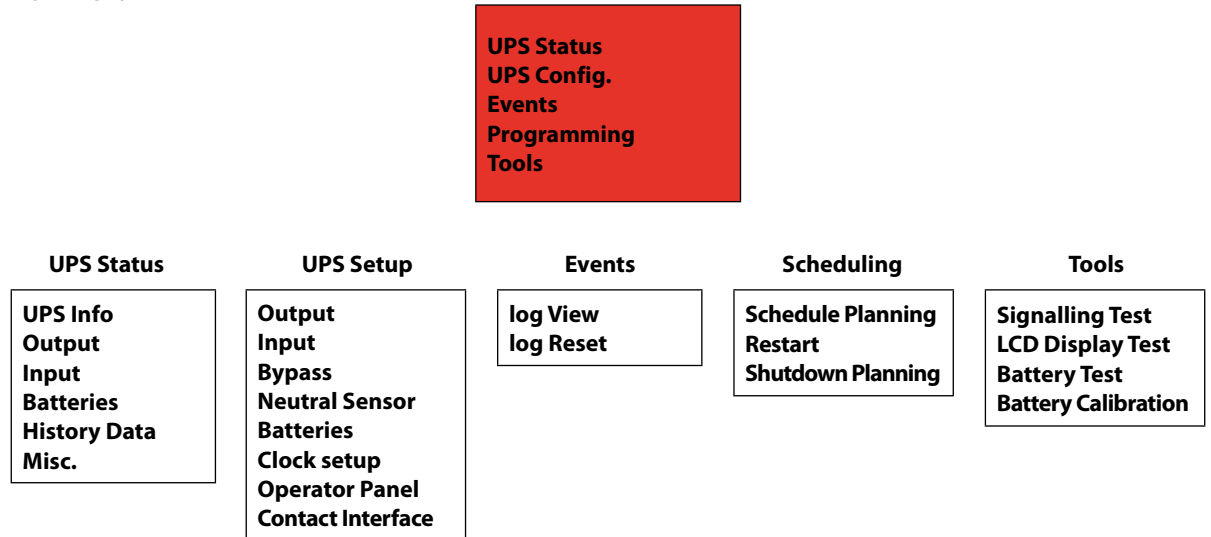

4.4 UPS Status

UPS Info

Mod Megaline	xxxx
POut Max	xxxx
SWVer.	xxxx
S/N	xxxxxxxx
Installed Modules	x
Faulty Modules	x



Mod	Indicates the name of the UPS
POut max	Indicates the potential maximum active power (W)
SWVer.	Software version
S/N	Serial number
Installed Modules	Number of power modules fitted
Faulty Modules	Number of power modules that have failed

Output

Power	xxxxx
Appar.Pow.	xxxx
V RMS	xxxx
I RMS	xxxx
Peak current	xx
Frequency	xx
I Crest factor	xx
Power fact.	xx



Power	Indicates the active power supplied (W)
Appar. Pow.	Indicates the apparent power supplied (VA)
V RMS	Indicates the effective voltage (V RMS) supplied at the UPS output
I RMS	Indicates the effective current (A RMS) supplied at the UPS output
Peak current	Indicates the peak current supplied at the UPS output (A)
Frequency	Indicates the frequency of the UPS output voltage (Hz)
I Crest factor	Indicates the crest factor, calculated as the ratio between the peak value and the effective value of the current absorbed by the load
Power fact.	Indicates the power factor for the load connected to the UPS

Input

Power	xxxx
Appar.Pow.	xxxx
V RMS	xxx
I RMS	xxxx
Peak Current	x
Frequency	x
I Crest factor	x
Power Fact	x



Power	Indicates the power received from mains (W)
Appar.Pow.	Indicates the apparent power received from mains (VA)
V RMS	Indicates the effective voltage (V RMS) at the UPS input
I RMS	Indicates the effective current (A RMS) received from mains
Peak Current	Indicates the peak current received from mains (A)
Frequency	Indicates the frequency of the UPS input voltage (Hz)
I Crest factor	Indicates the crest factor, calculated as the ratio between the peak value and the effective value of the current received from mains
Power Fact	Indicates the power factor applied to mains

Batteries

Voltage	xx
Residual Cap.	xxxx
Discharge count	xxxx
Usage	xxxx
Cal.dd/mm/yyhh:mm	
Ext. KB units	xx
Ext Chargers	xx



Voltage	Indicates the voltage at the terminals of the battery kits (V)
Residual Cap.	Indicates the percentage of battery charge
Discharge count	Indicates the number of battery discharge cycles
Usage	Hours of operation on battery power
Cal.	Indicates the date (day / month / year) and the time (hours / minutes) of the last battery calibration
Ext. KB units	Indicates the number of external KBs fitted
Ext Chargers	Indicates the number of external battery chargers fitted

History Data

UPS Ontime	xxxxx
BoosterOnTime	xxxx
DrainedOut N.	xxxx
Booster Int.	xxxx
Bypass Interv.	xxxx
OverheatCount	xxxx



UPS Ontime	Indicates the total number of hours of UPS operation
BoosterOnTime	Indicates the number of hours of UPS operation in booster mode (running on battery power)
DrainedOut N.	Indicates the number of times the UPS has completely discharged its batteries
Booster Int.	Number of times booster mode has intervened (running on battery power)
Bypass Interv.	Number of times the by-pass has intervened (refer to Config.UPS / By-pass menu)
OverheatCount	Number of times the thermal protection has been triggered (due to excessive load, for example)

Misc.

Int. Temp.	xx
Ext. Temp.	xx
Fan speed	xx



Int. Temp.	Indicates the internal temperature of the UPS, shown in Celsius
Ext. Temp.	Indicates the external temperature of the UPS, shown in Celsius
Fan speed	Indicates the speed of the UPS cooling fans, shown in a percentage format (100% = maximum speed)

4. Customising the UPS operating mode

4.5 UPS Setup

Output

Voltage Frequency N+x Redundancy		Voltage	To set the UPS output voltage (V)
		Frequency	To set the UPS output frequency (Hz) Nominal Value: to set a numerical value for the output frequency (50 or 60) Auto Selection: If enabled, the UPS reads the frequency of the input voltage and then synchronises the output to the same value. If disabled, the UPS uses the set Nominal Value .
		N+x Redundancy	To set the number of redundant boards (refer to NB: Redundancy Settings)

NB: Redundancy Settings

This function is used to manage the redundancy of the power modules. For example: a load requires N power modules; X power modules must be added to achieve N+X redundancy.

If the load applied exceeds the power supplied by N modules during operation, the UPS will signal the lack of redundancy

A numerical example is given below:

Load	Power boards	Total power (W)	Redundancy	Redundancy alarm (W)	Overload alarm (W)
3700	3	3750	0	no	3750
3700	4	5000	1	3750	5000
1500	4	5000	2	2500	5000
1000	4	5000	3	1250	5000

Input

PLL Enable Extended PLL Range		PLL Enable	If enabled, the UPS synchronises the output sine wave with the input. If disabled, the output voltage is not synchronised with the input. This is indicated by the flashing of the status warning light (green)
		Extended PLL Range	If enabled, the UPS synchronises the output voltage with the input for variations in frequency of +/-14% the nominal value. If disabled, the PLL is synchronised for variations in frequency of +/-2%.

NB: PLL Settings.

The PLL function ensures the UPS output frequency is synchronised with the input so that the changeover at zero takes place at the exact same time. Should the by-pass intervene, e.g. due to unanticipated loads, input-output synchronisation is guaranteed.

! ATTENTION If the PLL function is disabled, the automatic by-pass function is also disabled. Should the variation in input frequency be above the set range, the UPS will inhibit the PLL function and release the output and input lock. When the range returns within the set threshold, the PLL function will be reinstated automatically.

By-pass

Bypass Enable
Forced mode
DIP Speed
Off-line mode
Load Wait Mode



Bypass Enable	If enabled, the UPS manages by-pass intervention automatically. If disabled, the UPS will never switchover to by-pass operation. The UPS will switch off in cases of lengthy overload.
Forced mode	If enabled, the UPS enters permanent by-pass operation.
DIP Speed	This is to alter the sensitivity of the automatic intervention by the by-pass (when forced mode is disabled) SLOW: for loads that are not sensitive to dips in voltage or micro breaks but that cause frequent peaks. STANDARD: normal use FAST: loads sensitive to micro breaks
Off-line mode	If enabled, the by-pass operates as follows: - When mains power is present, the UPS runs permanently in by-pass mode - Should mains power fail, the UPS enters battery mode.
Load Wait Mode	ENABLE: switches the function on or off If enabled, the by-pass enters operation when the load is below the threshold set for "Minimum load threshold" Above this threshold, the by-pass stops working. Minimum load threshold: to set the value for the load for the switching on and off function (refer to NB: Load Waiting without mains power).

NB: Load Waiting without mains power.

In "Load Waiting" mode, the UPS will switch the by-pass on when the load is below the set threshold. Should there be no mains power, the UPS will switch off and only switch on again when mains power is restored.

! ATTENTION! Programming priority is as follows:

Operational function	Enable By-pass	Forced Mode	Off-line Mode	Load Waiting
Forced mode	ENABLED	ENABLED	X	X
Off-line mode	ENABLED	DISABLED	ENABLED	ENABLED
Off-line mode	ENABLED	DISABLED	ENABLED	DISABLED
Load waiting mode	ENABLED	DISABLED	DISABLED	ENABLED
Automatic mode	ENABLED	DISABLED	DISABLED	DISABLED
By-pass disabled	DISABLED	X	X	X

X: either setting (ENABLED or DISABLED).



4. Customising the UPS operating mode

Neutral Sensor

Enable Ignore While Run		Enable	If enabled, the UPS uses the neutral sensor to verify that the difference in voltage between neutral and earth is within safety limits. Should it go above the threshold, the UPS will automatically switchover and run on battery mode. If disabled, the UPS will ignore the neutral sensor.
		Ignore While Run	If enabled, the UPS only verifies neutral-earth voltage when it is switched on. If disabled, the UPS will verify neutrals earth voltage in all operating conditions.

Batteries

Capacity Manag.		Capacity Manag.	There are two options for programming ADVANCED MODE The warning signal for the end of autonomy is determined by reading the power absorbed by the load connected to the UPS and is displayed as the remaining autonomy time SIMPLE MODE The warning for the end of autonomy is calculated by reading the battery voltage. The chosen setting determines the type of battery programming menu displayed.
-----------------	---	------------------------	--

ADVANCED MODE Batteries

Set capacity Reserve Time		Set capacity	Advanced mode
		Reserve Time	Sets the warning signal for the end of battery autonomy using the remaining run time (minutes)

SIMPLE MODE
Batteries

Set capacity
Battery Thresholds



Set capacity	Simple mode
Battery thresholds	<p>Sets the warning signal for the end of battery autonomy using the battery voltage. There are two possible settings in the Mode menu</p> <p>If you select Mode – Automatic thresholds The UPS automatically calculates the voltage thresholds based on the load: the UPS will signal AUTONOMY RESERVE and END OF AUTONOMY, respectively, below these.</p> <p>If you select Mode – Fixed thresholds There are two options for this setting:</p> <p>1) Reserve threshold Sets the battery voltage threshold; the UPS will signal AUTONOMY RESERVE below this</p> <p>2) Exhaust threshold. Sets the battery voltage threshold; the UPS will signal END OF AUTONOMY below this.</p>

Batteries



Max Time On Batt.
Max time reserve
TurnOn Test Enable
Restart Enable
External options



Max Time On Batt.	Sets the maximum time for continuous operation in BATTERY mode, shown in seconds. If "0" is set, this function is disabled.
Max time reserve	Sets the maximum time for operation in BATTERY mode after the reserve limit has been reached, shown in seconds. If "0" is set, this function is disabled.
TurnOn Test Enable	If enabled, the batteries are tested each time the UPS is switched on. If disabled, the batteries are not tested when it is switched on again.
Restart Enable	If enabled, the UPS will switch on again when mains power is restored after switching off due to the end of its autonomy. If disabled, the UPS will not switch back on when mains power is restored after switching off due to the end of its autonomy.
External options	<p>Battery Chargers N° Sets the number of external battery chargers</p> <p>KB Units Sets the number of packs of three batteries fitted externally</p>

4. Customising the UPS operating mode



Setup Clock

23/06/03 -19:25:06 Monday	⇒	Setup Clock	 Sets the time and date  Select the setting to alter  Increases/Decreases the setting
------------------------------	---	--------------------	--

Operator Panel

Language Keyboard Beep Display Backlight Display contrast Password Change	⇒	Language	Set the language
		Keyboard Beep	Enables or disables the acoustic signal when buttons are pressed
		Display Backlight	Set the backlighting of the alphanumeric display - Fixed: always lit - Timed: the illumination switches off when the keypad has been inactive for a few seconds - Disabled: the illumination is always off
		Display contrast	Sets the contrast of the display
		Password Change	Sets the password to access the UPS settings

Contact Interface

Contact Interface	⇒	 It allows the setting of contacts normally closed   normally open
-------------------	---	---

4.6 Events

Log View Log Reset	⇒	Log View	Displays the events stored in the UPS memory, for example END OF AUTONOMY, OVERHEATING ALARMS etc.. with relative TIME and DATE
		Log Reset	Deletes the events stored in the UPS memory

4.7 Programming

Planning Schedule

Enable View/Edit Sched. sequence Reset



Enable	To enable or disable set programmes
View/Edit	To set and modify programmes. The following functions are available: <ul style="list-style-type: none"> - Batteries Test (verifies the status of the batteries) - Batt. Calibration (calibration of the batteries) - Turn on (to switch the UPS on) - Turn off (to switch the UPS off) - Absent (disables programming) <p>Each programme can be executed in the following ways:</p> <ul style="list-style-type: none"> - Daily "hour-minutes": executed every day at the set hourminutes; - Single "day-month-hour-minutes": executed once on the set "day-month-hour-minutes" - Weekly "day name-hour-minutes": executed every week on the set "day name-hour-minutes".
Sched. sequence	Used to display all the set programmes in the daily order (max 16)
Reset	Deletes all settings

Restart

Delay Min. autonomy



Delay	Duration, in seconds, of the warning signal that the UPS is about to switch back on
Min. Autonomy	Percentage of battery charge below which the UPS will not automatically switch back on

Shutdown

Delay



Delay	Duration, in seconds, of the warning signal that the UPS is about to switch back on
--------------	---

4.8 Tools

Segnalling Test LCD Display Test Battery Test Battery Calibration
--



Segnalling Test	Tests the warning lights. Press the ENTER button to execute the test of the Green, Yellow and Red warning lights and the Acoustic warning signal.
LCD Display Test	Tests the alphanumeric display. Press the ENTER button and all the available digits are shown on the alphanumeric display.
Battery Test	Tests the batteries. Contact your Service Centre in case of problems.
Battery Calibration	Calibrates the batteries, calculating the discharge curve for the batteries. We recommend this cycle be carried out when the batteries have been changed so that the UPS is able to provide precise information regarding the status of their charge.

5. Specifications

5.1 Construction specifications

	3 103 46	3 103 47	3 103 48	3 103 49	3 103 60	3 103 63	3 103 66	3 103 69	3 103 72
Weight (Kg.)	23,5	34	43	53	24+50	26,5+ 57,5	29+65	31,5+72,5	34+80
Size (LxHxP)	270 x 475 x 570 mm				270 x 475 x 570 mm x 2 cabinets				
Technology	PWM high frequency both for input stage and output stage. Microprocessor control logic								
Expandability	Optional upgrading to configurations with higher power by fitting one or more extra power modules inside the same cabinet, up to a maximum of 4. Optional upgrading of autonomy by fitting extra batteries inside, up to a maximum of 4 sets of 3, 12V, 9Ah batteries.				Optional upgrading to configurations with higher power by fitting one or more extra power modules inside the same cabinet, up to a maximum of 8. Optional upgrading of autonomy by fitting extra batteries inside, up to a maximum of 10 sets of 3, 12V, 9Ah batteries.				
Expandability	For greater autonomies, optional battery cabinets can be connected, each with a capacity of max 10 sets of 3, 12V, 9Ah batteries.								
Computer Interface	With logic levels, to interface with optional kits. Output with 9-pin male, SELV insulated connector. Standard serial RS232 for interfacing with personal computer using diagnostics software. Output with 9-pin, female, SELV insulated, connector.								
Remote control	Output with 9-pin male, SELV insulated connector for connection to optional remote control. Optional scheduling of UPS switch on/off and display of main UPS signals.								
Protection	Electronic protection against overloads, short circuits and excessive battery discharge. Operation blocked at end of autonomy. Inrush limitation when switching on. Sensor for correct neutral connection. Back-feed protection (electrical insulation for the safety of the input plug when running in battery mode). EPO contact (emergency power off)								
Synchronised By-pass	Automatic static and manual (optional). Intervenes in case of overload and operating anomaly.								

5.2 Environmental specifications

	3 103 46	3 103 47	3 103 48	3 103 49	3 103 60	3 103 63	3 103 66	3 103 69	3 103 72
Maximum altitude for storage	10.000 metres								
Storage temperature range	from -20° C to +50° C								
Operating temperature range	from 0° C to +40° C								
Range of relative humidity for operating	20-80% non condensing								
Grade of protection (IEC529)	IP 21								
Noise level at 1 metre	(<) 40dB A								

5.3 Electrical input specifications

	3 103 46	3 103 47	3 103 48	3 103 49	3 103 60	3 103 63	3 103 66	3 103 69	3 103 72
Nominal input voltage	230 V								
Input voltage range	from 184V to 264V with nom. load – from 100V to 264V with 50% of nom. load								
Nominal input frequency	50 Hz or 60 Hz +/-2% (autosensing and/or as selected by operator)								
Nominal input current	4,6A rms	8,9A rms	13,2A rms	17,7A rms	17,7A rms	22,4A rms	26,9A rms	31,25A rms	36,6A rms
Maximum input current	5,75A rms	11,2A rms	16,6A rms	22,2A rms	22,2A rms	27,8 rms	33,25A rms	38,9A rms	44,5A rms
Distortion of input current	THD < 3%								
Input power factor	> 0,99 dal 20% of nominal load								
Number of input phases	100% of nominal current								
In-rush current	Single phase								
Line fuse	25 AFF				32 + 32 AFF				
Battery charger directly from mains	0,8 A rms								

5. Specifications

5.4 Output wave form

	3 103 46	3 103 47	3 103 48	3 103 49	3 103 60	3 103 63	3 103 66	3 103 69	3 103 72
With mains operation	Sine wave								
With battery operation	Sine wave								
Type of operation	No break, on line UPS with passing neutral and double conversion								

5.5 Electrical output specifications when running on mains power

	3 103 46	3 103 47	3 103 48	3 103 49	3 103 60	3 103 63	3 103 66	3 103 69	3 103 72
Nominal output voltage	230 V \pm 1%								
Nominal output frequency	50 Hz / 60Hz synchronised (autosensing and/or as selected by operator)								
Output current with linear load and power factor 0,7	5,37A rms	10,75A rms	16,25A rms	21,6A rms	21,6A rms	27,2A rms	32,6A rms	38A rms	43,5A rms
Crest factor on output current	3,5								
Nominal output power VA	1250VA	2500VA	3750VA	5000VA	5000VA	6250VA	7500VA	8750VA	10000VA
Active output power with linear or nonlinear load P.F. 0,7	875W	1750W	2625W	3500W	3500W	4375W	5250W	6125W	7000W
Total harmonic distortion of output voltage with nominal load	< 0,5%								
Total harmonic distortion of output voltage with nominal non-linear load P.F.0,7	< 1%								
Overload capacity	300% for 1 second without By-pass intervention 200% for 5 seconds without By-pass intervention 150% for 30 seconds without By-pass intervention								
Number of output phases	Single phase								
AC-AC conversion efficiency with linear load PF = 1 and charged batteries:									
• with 50% load	80%								
• with 75% load	85%								
• with 100% load	92%								

5.6 Electrical output specifications when running on battery power

	3 103 46	3 103 47	3 103 48	3 103 49	3 103 60	3 103 63	3 103 66	3 103 69	3 103 72
Nominal output voltage	230 V ± 1%								
Output frequency	50 Hz / 60Hz ± 1% (autosensing and/or as selected by operator)								
Nominal output power VA	1250VA	2500VA	3750VA	5000VA	5000VA	6250VA	7500VA	8750VA	10000VA
Active output power with linear or nonlinear load P.F. 0,7	875W	1750W	2625W	3500W	3500W	4375W	5250W	6125W	7000W
Total harmonic distortion of output voltage	< 1%								
Overload capacity	160% impulsive								
Tolerated power factor range of applied load	from 0,7 to 1								
DC-AC conversion efficiency with linear load P.F. 1 and charged batteries:									
• with 50% load					80%				
• with 75% load					80%				
• with 100% load					80%				

⚠ ATTENTION: There is a danger of explosion should the batteries be replaced with the wrong type.
 Dispose of used batteries as per the instructions and precautions for their disposal on the battery label!

5. Specifications

5.7 Battery operation

	3 103 46			3 103 47			3 103 48			3 103 49		
Approximate autonomy in minutes with charged batteries	230 V ± 1%											
Percentage of applied load	50%	80%	100%	50%	80%	100%	50%	80%	100%	50%	80%	100%
Standard UPS	20	11	8	20	11	8	20	11	8	20	11	8
Recharge time up to 90% of total charge	5 - 6 hours according to level of discharge											
Specifications and quantity of batteries	n. 3 pcs 12V 9Ah, sealed, lead-acid, maintenance free batteries connected in series for each power module											
Reserve signals	from 32.2 V to 36V, can be programmed by operator											
Minimum voltage for battery operation during discharge	from 27V to 31.5V with automatic selection depending on applied load, or as programmed by operator											
Average battery life	3-6 years according to use and working temperature  WARNING! The batteries in the UPS are subject to a reduction in capacity depending on their age (a feature of lead batteries declared by their manufacturer in the technical manual). For example, the reduction of capacity of a 4-year-old battery can be as much as 40%, resulting in a proportional reduction of UPS autonomy time when running on battery power.											

	3 103 60			3 103 63			3 103 66			3 103 69			3 103 72		
Approximate autonomy in minutes with charged batteries															
Percentage of applied load	50%	80%	100%	50%	80%	100%	50%	80%	100%	50%	80%	100%	50%	80%	100%
Standard UPS	20	11	8	20	11	8	20	11	8	20	11	8	20	11	8
Recharge time up to 90% of total charge	5 - 6 hours according to level of discharge														
Specifications and quantity of batteries	n. 3 pcs 12V 9Ah, sealed, lead-acid, maintenance free batteries connected in series for each power module														
Reserve signals	from 32.2 V to 36V, can be programmed by operator														
Minimum voltage for battery operation during discharge	from 27V to 31.5V with automatic selection depending on applied load or as programmed by operator														
Average battery life	3-6 years according to use and working temperature.  WARNING! The batteries in the UPS are subject to a reduction in capacity depending on their age (a feature of lead batteries declared by their manufacturer in the technical manual). For example, the reduction of capacity of a 4-year-old battery can be as much as 40%, resulting in a proportional reduction of UPS autonomy time when running on battery power.														

5.8 By-pass Specifications

	3 103 46	3 103 47	3 103 48	3 103 49	3 103 60	3 103 63	3 103 66	3 103 69	3 103 72
Type of by-pass	Static and electromechanical								
Switchover time	zero								

5.9 Reference Standards

	3 103 46	3 103 47	3 103 48	3 103 49	3 103 60	3 103 63	3 103 66	3 103 69	3 103 72
Safety: Designed to satisfy standard	Conforms to standard EN 62040-1								
Electromagnetic compatibility: • immunity • emission	Conforms to standard EN 62040-2								
Typical performance	Conforms to standard EN 62040-3								

LEGRAND® reserves the right to vary data and specifications without notice

5.10 Routine maintenance

5.10.1 Cleaning

Before cleaning, it is essential to verify the following:

- all appliances connected to the UPS have been switched off
- all the appliances have been disconnected from the UPS
- the UPS has been disconnected from the mains power supply

5.10.2 Cleaning the cabinet

- Clean with a soft dry cloth

5.10.3 Cleaning the air vents

- Clean the air vents regularly by vacuuming them or using a soft brush

6. Troubleshooting

Problems	Solutions
When the UPS is switched on, the buzzer sounds and the red warning light makes alternating short-long flashes, then the UPS switches off after 15 seconds.	The connection of the neutral conductor is wrong: invert the power supply plug, or invert the connections of the neutral and phase input leads, or exclude the neutral sensor.
The UPS works but a short beep is heard every 12 seconds and the yellow warning light is lit without flashing.	<ul style="list-style-type: none"> - Check power is present at the mains outlet. - Check that the UPS power supply cable is correctly inserted in both the mains outlet and in the connector on the UPS itself. - Check the fuse located at the side of the input/output connector under the plastic housing (refer to fig.1 or 4)
The UPS works but it beeps intermittently and the red warning light and the yellow warning light are flashing.	There is an overload on the UPS output. Reduce the quantity of appliances connected so that the load does not exceed the maximum power that the UPS can supply. Alternatively, if the UPS is not in its maximum configuration, you can ask your Service Centre to increase the power of your UPS by fitting extra power boards and relative batteries inside the UPS cabinet.
The UPS beeps continuously and the yellow warning light flashes for about 15 seconds, after which the UPS switches off.	The UPS has completely flattened its batteries; it can only start up again when the mains input line is present. Check the magneto-thermal or differential switches that precede the UPS and the input fuse
The UPS works but the green warning light is flashing quickly.	The mains supply is out of the limits permitted for the voltage and/or frequency, but it can still be used by the UPS. However, the by-pass function is not operational.
The UPS beeps intermittently and the red warning light is flashing quickly.	The thermal protection has been tripped. Switch the UPS off and wait for a few minutes so that the internal temperature of the UPS can get back to normal. Check that the fans operate correctly and that the relative airflow is not obstructed (e.g. if the UPS is too close to a wall). There is a fault on one of the internal circuits. Contact your service centre.

**World Headquarters and
International Department**
87045 LIMOGES CEDEX FRANCE
☎: 33 5 55 06 87 87
Fax : 33 5 55 06 74 55
www.legrandelectric.com

┌ Installer stamp ───────────┐

└───────────────────────────┘